

M54455EVB User's Manual

by: Microcontroller Solutions Group

1 Introduction

1.1 Purpose

This document provides design and usage information for the Freescale M54455EVB evaluation, development and reference platform.

The M54455EVB platform provides an evaluation system for the Freescale MCF5445x ColdFire® V4m embedded microprocessor family. The MCF54455 is the superset device in the family and is the processor featured on this platform. This allows evaluation and development for the entire family on a single hardware platform.

1.2 Related Documents

- *MCF54455 Reference Manual*
- *M54455EVB Quick Start Guide*
- *M54455EVB Schematics*
- *MC34702 Switch-Mode with Linear Power Supply Datasheet*

Contents

1	Introduction	1
2	Overview	2
2.1	MCF54455 Overview	2
2.2	M54455EVB Overview	4
2.3	Memory Map Overview	6
2.4	I/O Back Panel	7
3	Installation and Configuration	7
4	Hardware Submodules	8
4.1	DDR SDRAM Interface	9
4.2	Reset Controller	9
4.3	MCF5445x Boot Options	9
4.4	System Clocks	12
4.5	SPI Flash	14
4.6	Flash	14
4.7	PCI	15
4.8	Audio	19
4.9	BDM and JTAG	20
4.10	USB	21
4.11	Ethernet	21
4.12	ATA	22
4.13	FPGA	22
4.14	CPLD	26
4.15	Interrupts	33
4.16	Serial Interface Header	33
4.17	Serial Ports	34
4.18	Logic Analyzer Connections	35
4.19	Power Regulation	35
4.20	Jumpers, Headers, and Switches	35
5	U-Boot	37
6	Revision History	37

- *Universal Serial Bus Specification, Revision 2.0*
- *PCI Local Bus Specification, Revision 2.2*
- *DDR2 SDRAM Specification (JESD79-2C)*

2 Overview

2.1 MCF54455 Overview

The MCF54455 is the host processor for the M54455EVB. [Figure 1](#) shows a top-level block diagram of the MCF54455 superset device. The following is a brief summary of the functional blocks in the MCF54455 superset device.

- Version 4 ColdFire Core with MMU and EMAC
 - Up to 410 Dhrystone 2.1 MIPS @ 266 MHz
- 16 KBytes instruction cache and 16 KBytes data cache
- 32 Kbytes internal SRAM
- Support for booting from SPI-compatible flash, EEPROM, and FRAM devices
- Crossbar switch technology (XBS) for concurrent access to peripherals or RAM from multiple bus masters
- 16 channel DMA controller
- 16-bit 133MHz DDR/mobile-DDR/DDR2 Controller
- USB 2.0 On-the-Go controller with ULPI support
- 32-bit PCI controller @ 66MHz
- ATA/ATAPI controller
- Two 10/100 Fast Ethernet Controllers (FEC_n)
- Cryptographic acceleration unit (CAU)
- Random number generator
- Synchronous serial interface
- Four periodic interrupt timers
- Four 32-bit timers with DMA support
- DMA-supported serial peripheral interface (DSPI)
- Three UARTs
- I²C bus interface

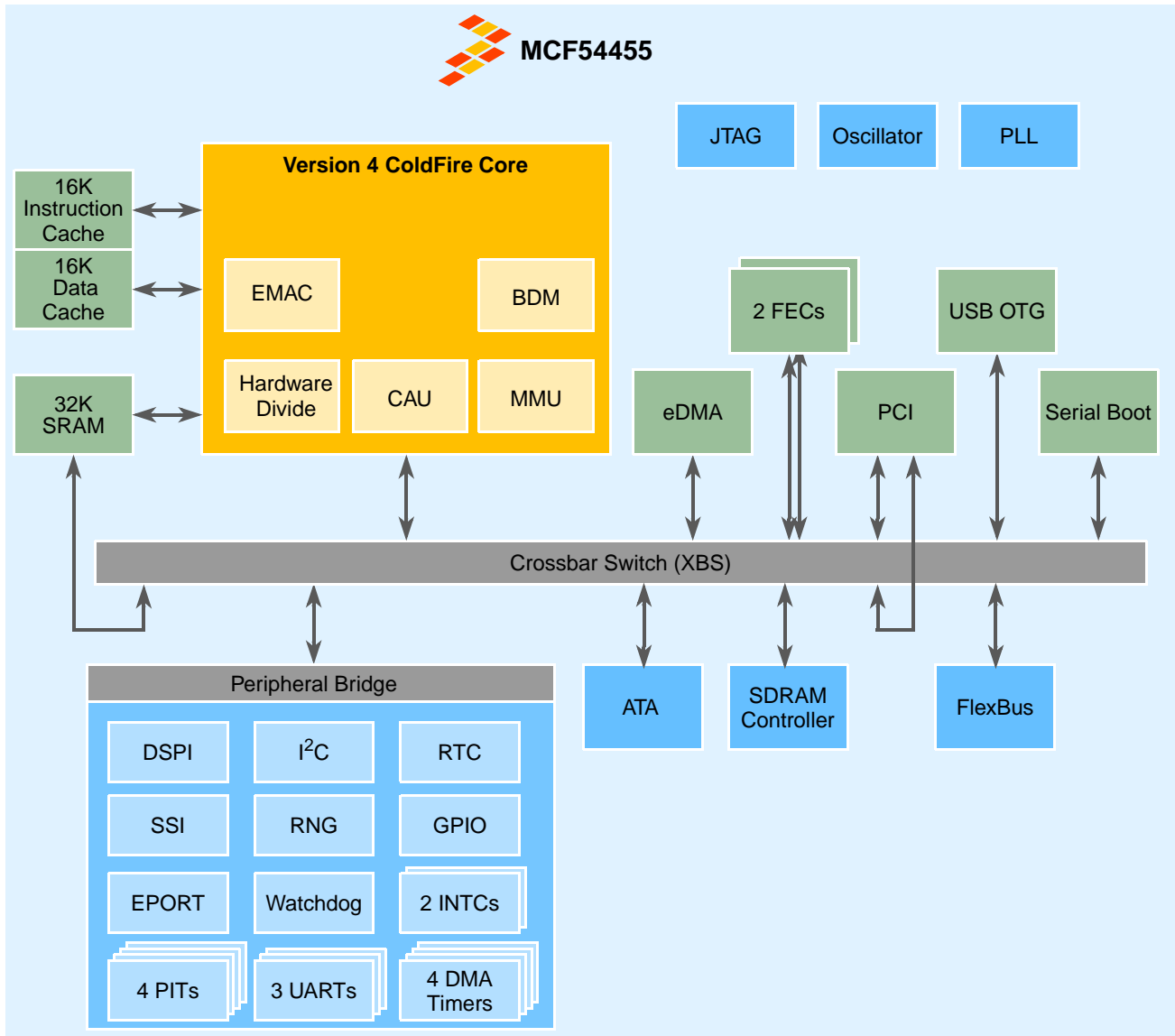

LEGEND

- | | | | |
|-----------------------|---|----------------|---|
| ATA | – Advanced Technology Attachment Controller | INTC | – Interrupt controller |
| BDM | – Background debug module | JTAG | – Joint Test Action Group interface |
| CAU | – Cryptography acceleration unit | MMU | – Memory management unit |
| DSPI | – DMA serial peripheral interface | PCI | – Peripheral Component Interconnect |
| eDMA | – Enhanced direct memory access | PIT | – Programmable interrupt timers |
| EMAC | – Enhanced multiply-accumulate unit | PLL | – Phase locked loop module |
| EPORT | – Edge port module | RNG | – Random Number Generator |
| FEC | – Fast Ethernet Controller | RTC | – Real time clock |
| GPIO | – General Purpose Input/Output | SSI | – Synchronous Serial Interface |
| I²C | – Inter-Integrated Circuit | USB OTG | – Universal Serial Bus On-the-Go controller |

Figure 1. MCF54455 Block Diagram

2.2 M54455EVB Overview

The M54455EVB provides hardware to evaluate as many of the configurations of the MCF5445x family as possible. The M54455EVB features:

- Freescale MCF54455 ColdFire microprocessor
- DDR2 SDRAM (256 MByte)
- Two NOR flash memory devices (16 MByte, 512 KByte)
- Serial flash
- MRAM (512 KByte, accessible through FPGA Flexbus interface)
- Four PCI slots (32-bit, for MCF5445x as a PCI host system)
- Two-port Ethernet interface
- 40-pin ATA connector
- Audio interface (I²S mode of SSI module connected to audio codec)
- Multiple USB interface options
 - FS/LS Host via on-chip transceiver with host support (Type A receptacle)
 - HS/FS/LS dual-role via external ULPI PHY (Mini-AB receptacle)
- Two RS232 serial ports (RS232 transceivers on UART0 & UART1)
- One USB serial port (UART0 serial converted to USB converted on UART0)
- Built-in P&E Micro USB Multilink debug interface
- Standard 26-pin BDM header
- Serial interface header for access to timers, interrupts, DSPI, I²C, and more
- Clock generation logic adjustable via I²C
- LEDs and 7-segment display programmable via CPLD and FPGA
- Low-profile, micro-ATX computer case with built-in power supply



Figure 2. M54455EVB Kit

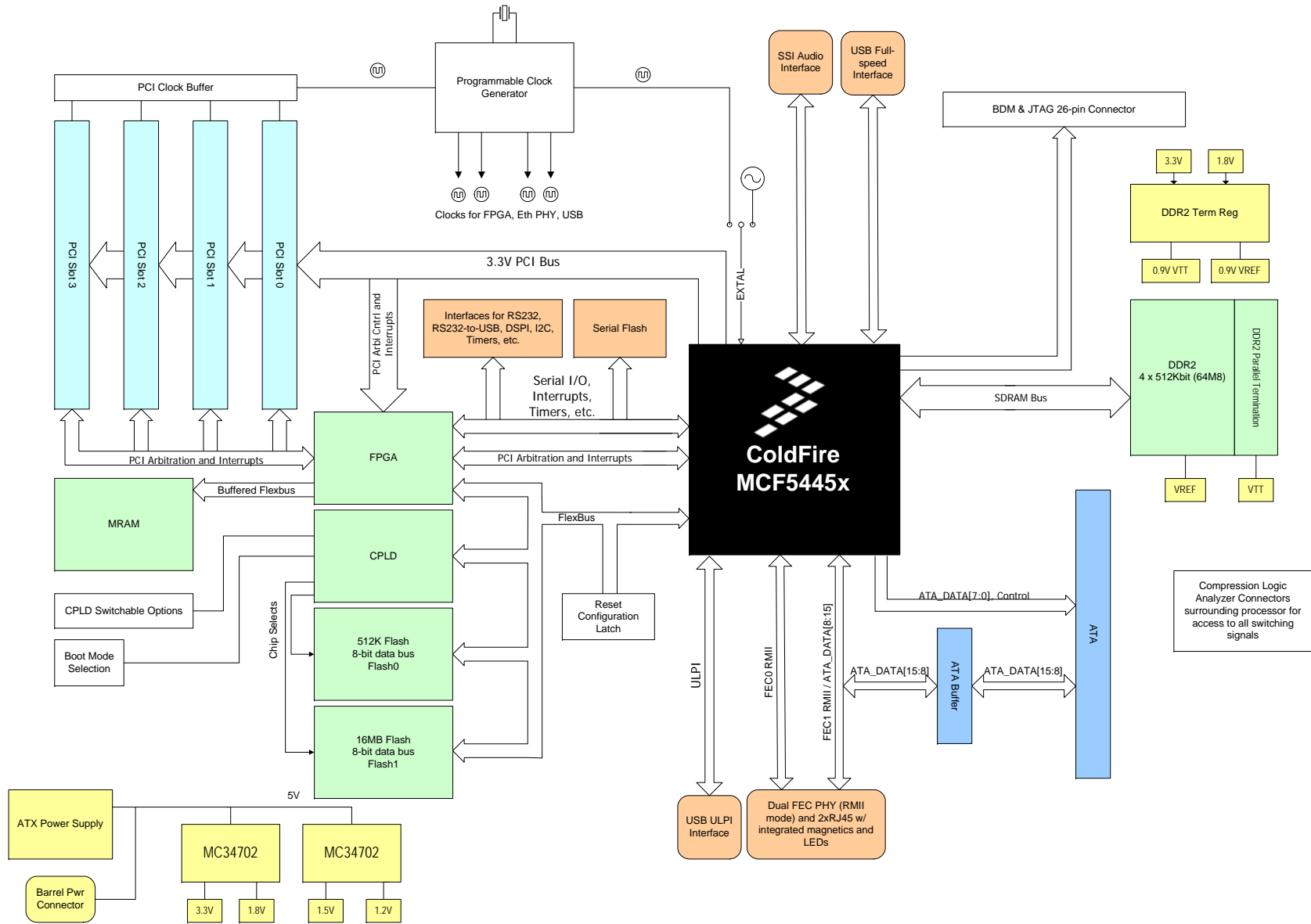

Figure 3. M54455EVB Block Diagram

2.3 Memory Map Overview

Figure 1 illustrates the overall memory map for the MCF54455 and M54455EVB.

Table 1. M54455EVB Memory Map

Function	Start Address	End Address	Size
Flexbus—Flash1	0x0000_0000	0x00FF_FFFF	16 MB
Flexbus—Flash0	0x0400_0000	0x0407_FFFF	512 KB
Flexbus—CPLD ¹	0x0800_0000	0x08FF_FFFF	16 MB
Flexbus—FPGA/MRAM ¹	0x0900_0000	0x09FF_FFFF	16 MB
DDR2 SDRAM	0x4000_0000	0x4FFF_FFFF	256 MB
MCF5445x Internal SRAM	0x8000_0000	0x8000_7FFF	32 KB
ATA	0x9000_0000	0x9FFF_FFFF	256 MB
PCI	0xA000_0000	0xBFFF_FFFF	512 MB
Flexbus—Unused	0xC000_0000	0xDFFF_FFFF	512 MB
Reserved	0xE000_0000	0xEFFF_FFFF	256 MB
Internal Peripheral Space	0xF000_0000	0xFFFF_FFFF	256 MB

¹ The CPLD and FPGA sections contain details on the memory-mapped registers within these address spaces.

Much of the memory map is dictated by the MCF5445x memory map. Refer to the “Overview” and “Crossbar Switch” sections of the *MCF54455 Reference Manual* for more details.

2.4 I/O Back Panel

Refer to [Figure 4](#) for the I/O back panel descriptions.

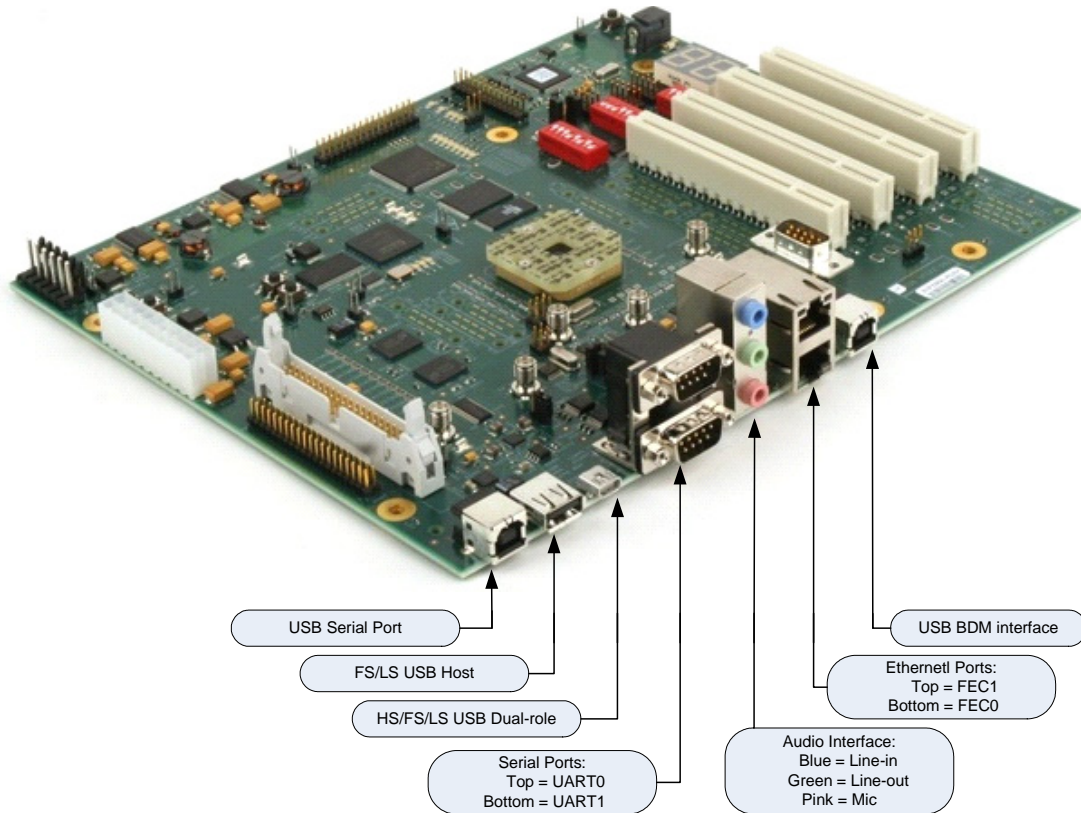

Figure 4. M54455EVB I/O Back Panel Port Locations

3 Installation and Configuration

The M54455EVB comes pre-programmed with U-Boot and Linux pre-configured to run a demo application. This section describes how to setup the evaluation board to access the bootloader to start Linux.

The default communication interface with the M54455EVB is a simple serial port console. A terminal emulator on a host PC and the supplied serial cable is required to interact with the serial port. Alternately, a USB cable can be used if the USB serial port is configured for use (refer to [Section 4.17](#), “Serial Ports” for details).

The basic installation steps are as follows:

1. Plug in the case’s power supply with the power cable provided.
2. Connect one end of the provided serial cable to the DB9 serial port connector labelled UART0 (Refer to [Figure 4](#)).
3. Connect the other end of the serial cable to a free DB9 serial port connector on a host PC.
4. Open the terminal emulator of your choice (e.g. HyperTerminal, Tera Term, minicom, etc.).

5. Configure the COM port as follows:

Table 2. Default Serial Console Settings

Parameter	Setting
Baud Rate	115,200 bps
Data bits	8
Parity	None
Stop bits	1
Flow Control	None or Software (Xon/Xoff)

6. Press the power switch on the front of the computer case and the U-Boot banner (example below) should appear in the terminal window.

```
U-Boot 1.2.0-g4a442d31-dirty (Aug 23 2007 - 11:14:19)

CPU:   Freescale MCF54455 (Mask:48 Version:1)
CPU CLK 266 Mhz BUS CLK 133 Mhz FLB CLK 33 Mhz
INP CLK 33 Mhz VCO CLK 533 Mhz
Board: Freescale M54455 EVB
I2C:   ready
DRAM:  256 MB
FLASH: 16.5 MB
In:    serial
Out:   serial
Err:   serial
Net:   FEC0, FEC1
IDE:   Bus 0: not available  Status = 0x60
->
```

Linux and a root file system are preprogrammed into the second Flash device (Flash1) at address 0x0000_0000. A demo application automatically runs when Linux is started. A network connection is required for the web server portion of the demo to work.

7. Plug one end of the provided Ethernet cable into a network or host PC with a DHCP server running. Plug the other end of the cable into the FEC0 interface (bottom RJ45 receptacle) of the M54455EVB.
8. To boot Linux, issue the following U-Boot command.
-> bootm 0
9. The demo application prints out a banner message including the IP address that it obtained from the DHCP server. Launch a web client (e.g. Firefox or Internet Explorer) and copy this IP address into the web browser. The M54455EVB serves up a web page with more information on the available demos.

4 Hardware Submodules

The following sections describe the hardware submodules of the M54455EVB.

4.1 DDR SDRAM Interface

The MCF5445x DDR SDRAM controller has the following features:

- Supports a glueless interface to DDR, DDR2, and mobile/low-power DDR SDRAM devices
- Support for 16-bit fixed memory port width
- 16-byte critical word first burst transfer
- Up to 14 lines of row address, up to 11 column address lines, 2 bits of bank address, and two chip selects.
- Supports up to 512 MByte of memory; minimum memory configuration of 8 MByte
- Supports page mode to maximize the data rate
- Supports sleep mode and self-refresh mode

The M54455EVB features 256 MBytes of DDR2 SDRAM. Four 8-bit wide Micron MT47H64M8 (512 Mbit) devices are arranged as two $16 \text{ M} \times 8 \times 4$ banks per SDRAM controller chip select. This results in two 16-bit wide, 128 MBytes blocks of DDR2 memory

The SDRAM interface is terminated with parallel termination resistors. The MCF5445x does not provide control for the DDR2 on-die termination. The ODT pins on the DDR2 devices are connected to control signals from the CPLD for test purposes only. These signals are disabled in the normal functional mode.

4.2 Reset Controller

The reset controller on the M54455EVB is implemented in a Xilinx XC95144XL CPLD. The CPLD controls the state of the system reset signal (SYSRESET) gathers reset information from a pushbutton reset (SW2), the BDM interface, and the FPGA (FPGA_DONE). At system power-on, the CPLD holds SYSRESET asserted until the FPGA has loaded its image from the platform flash PROM and asserted the FPGA_DONE signal. After system power-on, the CPLD asserts SYSRESET when it detects the assertion of any of the reset sources.

4.3 MCF5445x Boot Options

During a system reset, the CPLD also drives the boot mode configuration signals into the MCF5445x. The MCF5445x has three boot mode options:

- Boot with default configuration constants specified in the RCON register,
- Boot with configuration data specified by the Flexbus FB_AD[7:0] pins, and
- Boot with configuration data obtained from an external SPI memory through the serial boot facility.

In all of these cases, the boot code is fetched from an external memory connected to the Flexbus on FB_CS0 with the possible exception of the serial boot mode. In serial boot mode, if the boot load length field (BLL) in the reset configuration data stored in the SPI memory is non-zero, then boot code is loaded from the SPI memory instead of from Flexbus.

The MCF5445x boot mode is determined by the state of the BOOTMOD[1:0] input pins during the rising edge of RSTOUT (MCF5445x reset output signal). The CPLD drives BOOTMOD[1:0] to the values that

are set on the CPLD mode signals (CPLD_MODE[1:0]). The CPLD_MODE signals are set by the CPLD configuration switch, SW1. See [Section 4.14, “CPLD”](#) for more details. [Table 3](#) shows the SW1 settings and their corresponding boot mode configurations.

Table 3. M54455EVB Boot Mode Selection

BOOTMOD[1:0]	SW1[2:1]	Meaning
00	ON:ON	Boot from Flexbus with defaults (from RCON register)
01	ON:OFF	Reserved
10	OFF:ON	Boot from Flexbus and override defaults via data bus (FB_AD[7:0])
11	OFF:OFF	Boot from Flexbus and override defaults via serial boot facility (SPI memory)

4.3.1 Default Configuration (SW1[2:1] = ON:ON)

If the BOOTMOD pins are 00 during reset, the MCF5445x RCON register determines the chip configuration after reset, regardless of the states of the external data pins. The RCON register specifies the following default configuration for the MCF54455:

- PCI enabled, muxed Flexbus address/data, 8-bit port-size boot
- PLL enabled
- PCI host mode
- 66MHz PCI slew rate mode
- PLL multiplier: $f_{VCO} = 6 \times f_{REF}$

4.3.2 Parallel Configuration (SW1[2:1] = OFF:ON)

If the BOOTMOD pins are 10 during reset, the MCF5445x configuration after reset is determined according to the levels driven onto the FB_AD[7:0] pins. On the M54455EVB, the FB_AD[7:0] pins are actively driven by an 8-bit buffer enabled when the MCF5445x \overline{RSTOUT} signal is asserted. The values driven by the buffer are set by the SW3 DIP switch settings. Refer to [Table 4](#) for the configuration setting information.

Table 4. MCF54455 Parallel Configuration During Reset

Pin(s) Affected	Corresponding SW3 Settings			Function
	SW3[8]	SW3[7]	SW3[6]	Flexbus, PCI, Port Size Mode
FB_AD[31:0], PCI_*	ON	ON	ON	PCI, muxed FB addr/data, 8-bit boot ¹
	ON	ON	OFF	No PCI, muxed FB addr/data, 16-bit boot
	ON	OFF	ON	No PCI, muxed FB addr/data, 8-bit boot
	ON	OFF	OFF	No PCI, muxed FB addr/data, 32-bit boot
	OFF	ON	ON	PCI, muxed FB addr/data, 16-bit boot
	OFF	ON	OFF	No PCI, non-muxed FB addr/data, 16-bit boot
	OFF	OFF	ON	No PCI, non-muxed FB addr/data, 8-bit boot
	OFF	OFF	OFF	No PCI, non-muxed FB addr/data, 32-bit boot
	Output Clocks	SW3[5]		
ON			Limp mode	
OFF			PLL mode	
(none)	SW3[4]			PCI Host/Agent Mode (when in a PCI mode)
	ON			PCI host mode
	OFF			PCI agent mode
(none)	SW3[4]			Oscillator Mode (when in a No PCI mode)
	ON			Oscillator bypass mode
	OFF			Crystal oscillator mode
PCI_*	SW3[3]			PCI Slew Rate Mode (when in a PCI mode)
	ON			66 MHz slew rate mode
	OFF			33 MHz slew rate mode
(none)	SW3[3]	SW3[2]	SW3[1]	PLL Multiplier (when in a No PCI mode)
	ON	ON	ON	$f_{VCO} = 8 \times f_{REF}$
	ON	ON	OFF	$f_{VCO} = 16 \times f_{REF}$
	ON	OFF	ON	$f_{VCO} = 6 \times f_{REF}$
	ON	OFF	OFF	$f_{VCO} = 12 \times f_{REF}$
	OFF	ON	ON	$f_{VCO} = 18 \times f_{REF}$
	OFF	ON	OFF	$f_{VCO} = 24 \times f_{REF}$
	OFF	OFF	ON	$f_{VCO} = 10 \times f_{REF}$
	OFF	OFF	OFF	$f_{VCO} = 20 \times f_{REF}$

Table 4. MCF54455 Parallel Configuration During Reset (continued)

Pin(s) Affected	Corresponding SW3 Settings		Function
	SW3[2]	SW3[1]	
(none)			PLL Multiplier (when in a PCI mode)
	ON	ON	$f_{VCO} = 8 \times f_{REF}$ e.g. CPU = 266 MHz; PCI = 66 MHz
	ON	OFF	$f_{VCO} = 16 \times f_{REF}$ e.g. CPU = 266 MHz; PCI = 33 MHz
	OFF	ON	$f_{VCO} = 6 \times f_{REF}$ e.g. CPU = 200 MHz; PCI = 66 MHz
	OFF	OFF	$f_{VCO} = 12 \times f_{REF}$ e.g. CPU = 200 MHz; PCI = 33 MHz

¹ This setting is required if booting from Flash device, Flash0, or Flash1.

4.3.3 Serial Configuration (SW1[2:1] = OFF:OFF)

If the BOOTMOD pins are 11 during reset, then the chip configuration after reset is determined by data obtained from an external SPI memory through serial boot using the SBF_DI, SBF_DO, SBF_CS, and SBF_CK signals. The internal configuration signals are driven to reflect the data being received from the external SPI memory to allow for module configuration. See “Serial Boot Facility” and “Chip Configuration Module” chapters of the *MCF54455 Reference Manual* for more details.

4.4 System Clocks

A single Cypress CY22393 device generates all of the clock signals on the M54455EVB. Alternatively, you can supply the clock signals using external SMA connectors for test purposes. The different clock signals and configurations are described below. Please refer to the *MCF54455 Reference Manual* for further information on the clocking requirements for the MCF5445x family.

The CY22393 is programmed prior to assembly on the M54455EVB PCB. There is an I²C interface on this device that allows it to be reprogrammed. However, these settings are not retained following a power-on reset.

The state of the CY22393's S2 frequency control input pin is controlled by a jumper (H4[3:4]) and the system FPGA signal, CLK_GEN_S2. The FPGA uses two conditions to determine how to drive the CLK_GEN_S2 signal: the M66EN signal and a programmable bit in the PCICLKCFG register. The M66EN signal is a PCI bus signal that is tied to logic 0 if a 33MHz PCI card is installed in any one of the four PCI slots. By default, the PCICLKCFG[CLKGENS2EN] bit is cleared, which forces the clocks to 33 MHz. [Table 5](#) summarizes the three controls over the state of the S2 pin.

Table 5. PCI Clocks and MCF5445x Input Clock Speed Selection

M66EN signal	FPGA_PCICLKCFG [CLKGENS2EN]	H4[3:4] Jumper	Resulting S2 Value	CPU input and PCI Bus Speed
0	—	—	0	33 MHz
—	0¹	—	0¹	33 MHz¹
—	—	Jumper Shunt ON	0	33 MHz
1¹	1	Jumper Shunt OFF¹	1	66 MHz

¹ Indicates the default values.

The following pseudocode illustrates the input clock determination logic:

```

if ((H4[3:4] shunt is not installed) and
    (no 33MHz PCI cards installed (M66EN logic 1)) and
    (FPGA_PCICLKCFG[CLKGENS2EN] is set))
{
    S2 = 1; PCI Clocks and MCF5445x input clock are 66MHz
}
else
{
    S2 = 0; PCI Clocks and MCF5445x input clock are 33MHz
}

```

Refer to [Section 4.13, “FPGA”](#) for details on the FPGA_PCICLKCFG register. [Table 6](#) shows the default system clock frequencies generated by the CY22393.

Table 6. Clock Generator Outputs

Clock	CY22393 Output	S2 Value	Default Clock Frequency (MHz)	Description
MCF5445x Input Clock	CLKA	0	33	Clock driven into the EXTAL pin on the MCF5445x. This is the operating frequency in limp mode and the PLL reference when the PLL is enabled.
		1	66	
PCI Clock	CLKB	0	33	Duplicate of the MCF5445x input clock. This is driven to clock buffers and on to each PCI slot, the FPGA, and the CPLD.
		1	66	
MCF5445x USB Clock	CLKC	N/A	Disabled ¹	MCF5445x USB clock ¹
ULPI PHY Clock	CLKD	N/A	24	Reference clock for the external ULPI PHY
RMII Ethernet Clocks	CLKE	N/A	50	Duplicate, matched clocks driven to each MCF5445x FEC RMII clock input and to the external dual Ethernet PHY

¹ CLKC is disabled by default. Instead, USBCLKIN is driven by the 60MHz clock output of the ULPI PHY. However, JP918 provides an option to select CLKC as the source for USBCLKIN. If this is selected, the CY22393 must be programmed via I²C to generate a 60MHz clock signal.

There is a provision on the M54455EVB for clocking the MCF5445x with a 25MHz crystal instead of the 33/66MHz external clock. A cut-trace (CT11) can be modified to route the provided 25MHz crystal oscillator circuit to the EXTAL input. Refer to [Figure 5](#) for details on how to make this modification.

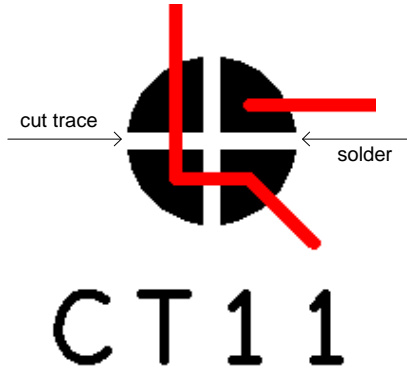

Figure 5. MCF5445x Input Clock Selection Cut-Trace

4.5 SPI Flash

A 16 Mbit SPI flash is connected to the MCF5445x via the DSPI interface. This same SPI flash can be used to store reset configuration parameters and boot code when using the serial boot facility. Refer to [Section 4.3, “MCF5445x Boot Options”](#) for more information on how to configure the M54455EVB for serial boot.

4.6 Flash

The M54455EVB features two flash devices connected to the FlexBus expansion bus. The smaller of the two flashes is a 512KByte, 8-bit wide AT49BV040 (or compatible) device referred to as Flash0. This device contains the U-Boot bootloader. The larger of the two flashes is a 16 MByte, 8-bit wide 28F128J3D (or compatible) device referred to as Flash1. By default, this flash device is programmed with a Linux image, but it can be reprogrammed and used as a boot device if desired.

The selection of a boot flash device is achieved with a CPLD mode switch setting, specifically CPLD_MODE2 which is controllable by DIP switch SW1[3]. The device that is connected to the global chip-select from the MCF5445x ($\overline{\text{FB_CS0}}$) is the boot device. The other device is connected to $\overline{\text{FB_CS1}}$. [Table 7](#) shows the boot device selection settings.

Table 7. Flash Chip Select Configuration

SW1[3]	Meaning	Application
OFF	Flash1 is the boot device $\overline{\text{FLASH1_CS}} = \overline{\text{FB_CS0}}$ $\overline{\text{FLASH0_CS}} = \overline{\text{FB_CS1}}$	Boot custom image
ON	Flash0 is the boot device $\overline{\text{FLASH1_CS}} = \overline{\text{FB_CS1}}$ $\overline{\text{FLASH0_CS}} = \overline{\text{FB_CS0}}$	Boot U-Boot

4.7 PCI

The MCF5445x processor's PCI controller module has the following features:

- Compatible with PCI 2.2 specification
- Supports up to four external PCI masters
- 32-bit target and initiator operation
- 33–66 MHz operation with PCI bus to internal bus divider ratios of 1:1, 1:2, 1:3, 2:3, 1:4, and 1:5.
- Support for host and agent configurations.

The M54455EVB is designed to feature the MCF5445x as a PCI host. It provides four, 32-bit, 3.3V PCI slots. The IDSEL pins on each of the slots and the MCF5445x is connected to a different PCI_AD signal. [Table 8](#) shows the IDSEL connections.

Table 8. PCI IDSEL Assignments

PCI Slot	IDSEL Assignment
Slot 0	PCI_AD17
Slot 1	PCI_AD18
Slot 2	PCI_AD19
Slot 3	PCI_AD20
MCF5445x	PCI_AD16

4.7.1 PCI Clocking

The MCF5445x does not output a PCI clock. The PCI controller of the MCF5445x is timed to the input reference clock on EXTAL. Therefore, the input reference clock to the MCF5445x is matched to each of the PCI slots on the M54455EVB to maintain clock phase alignment and ensure proper PCI timings.

The M54455EVB is designed to support 33- and 66-MHz 32-bit PCI cards. However, the speed of the PCI clocks and input clock is limited to that of the slowest device by logic on the M54455EVB. The frequency of these clocks is controlled by an input (S2) into the clock generator logic. The FPGA automatically adjusts this control signal based on the M66EN signal from each PCI slot. The S2 signal is also controllable by a jumper and a memory mapped register in the FPGA. See [Section 4.4, “System Clocks”](#) and [Section 4.13, “FPGA”](#) for more information. [Table 5](#) provides a summary of the PCI bus speed controls.

4.7.2 PCI Power

The PCI is only available if an ATX supply is used to power the board. If the optional barrel power connector is used, then the ATX3V3 supply is not available. This also affects the clocking of the MCF5445x. The M66EN signal is pulled-up to the ATX3V3 supply. Without this supply, the M66EN signal is detected as a logic 0 and the CPU input reference frequency is forced to 33MHz.

4.7.3 PCI Arbitration

By default, the EVB uses the MCF5445x on-chip PCI arbiter, and the request/grant signals from the PCI slots are routed directly to the MCF5445x. The board does provide cut-trace options to allow you to route these PCI arbitration signals to the FPGA. It would then be left to you to implement an external arbitration scheme in the FPGA.

The following figures describe how to alter the M54455EVB to route the PCI arbitration signals to the FPGA. Reference designators for the cut-trace board footprints are CT1-CT10. CT1-CT2, CT5-CT7 and CT9 can be found near the PCI slots (J14, J15, J16, J17), and CT8, CT10, CT3 and CT4 can be found near the MCF5445x (U1).

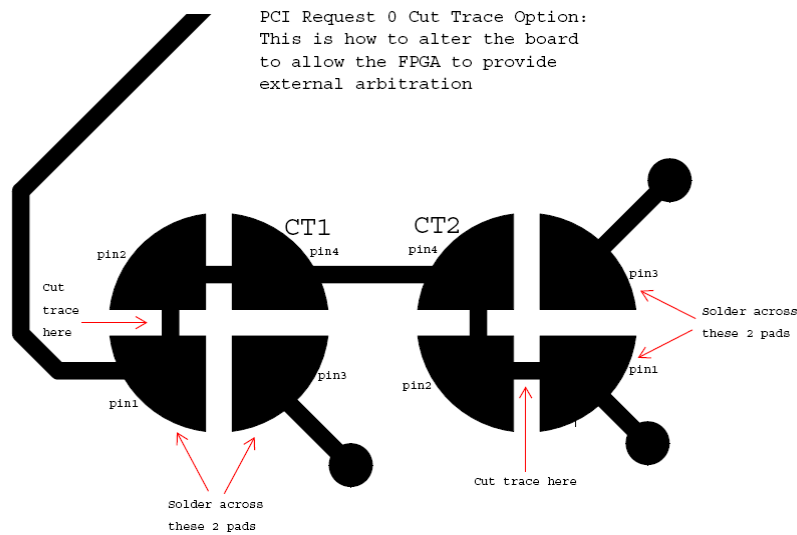

Figure 6. PCI Request 0 Cut Trace Option—Use FPGA for Arbitration

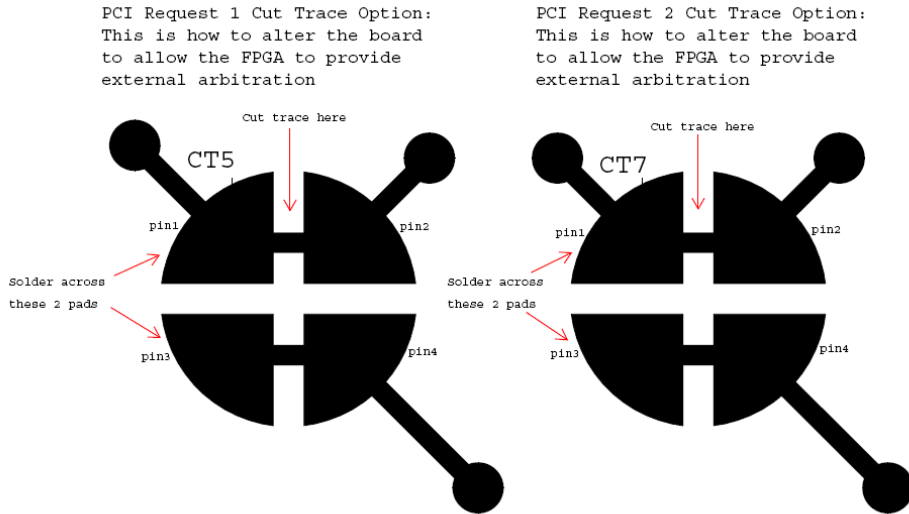

Figure 7. PCI Request 1 and Request 2 Cut Trace Option—Use FPGA for Arbitration

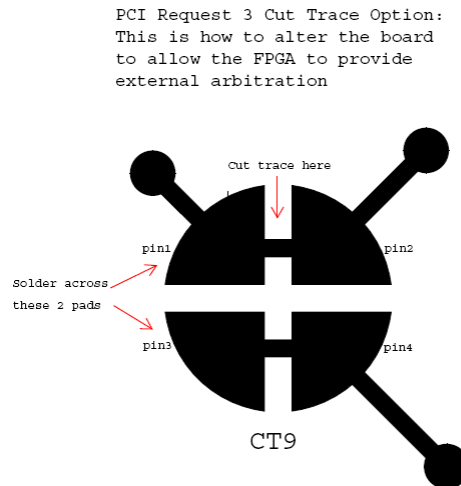

Figure 8. PCI Request 3 Cut Trace Option—Use FPGA for Arbitration

PCI Grant 0 Cut Trace Option:
 This is how to alter the board
 to allow the FPGA to provide
 external arbitration

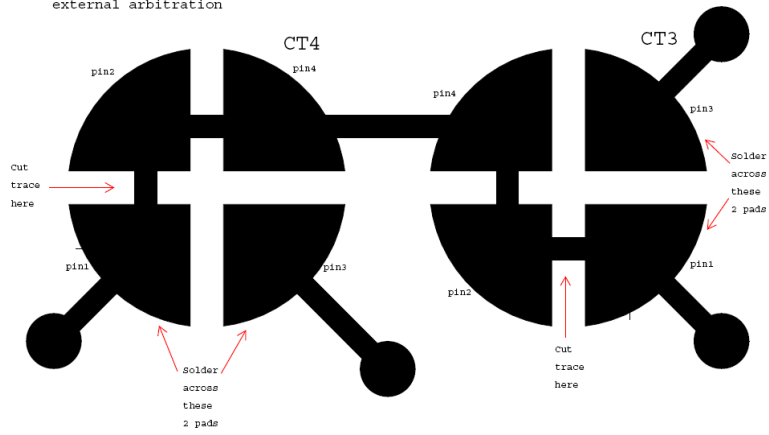

Figure 9. PCI Grant 0 Cut Trace Option—Use FPGA for Arbitration

PCI Grant 1 Cut Trace Option:
 This is how to alter the board
 to allow the FPGA to provide
 external arbitration

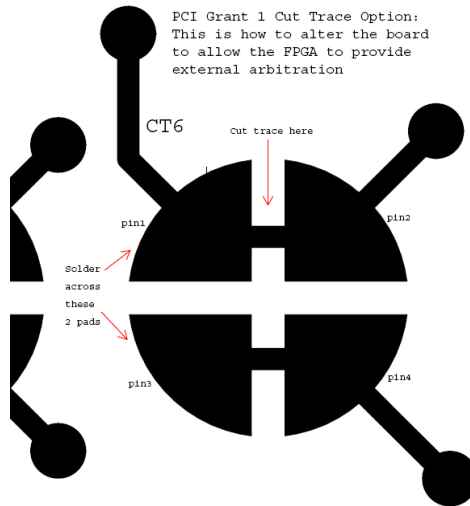

Figure 10. PCI Grant 1 Cut Trace Option—Use FPGA for Arbitration

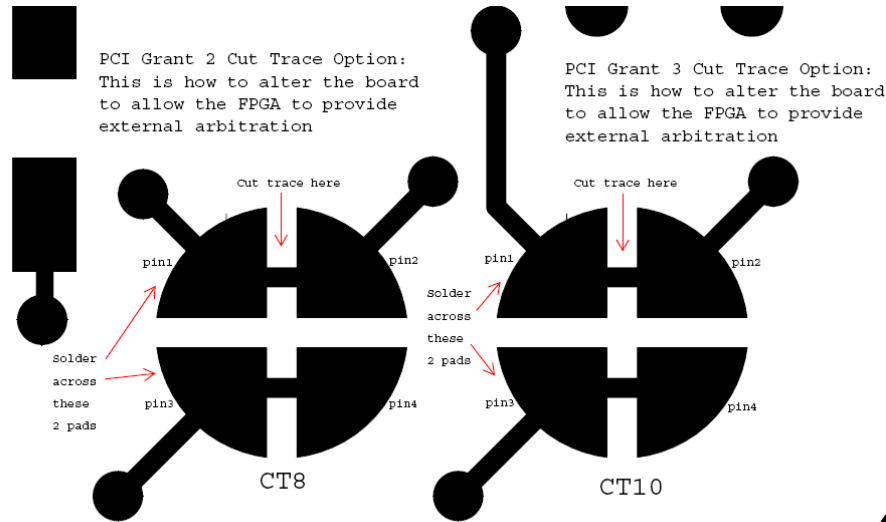

Figure 11. PCI Grant 2 and Grant 3 Cut Trace Option—Use FPGA for Arbitration

4.7.4 PCI Interrupts

The four interrupt signals on each PCI slot (INTA–INTD) are wire ORed together to form one interrupt source per slot. These four interrupt sources are routed to the system FPGA. The FPGA routes these interrupts to the MCF5445x as programmed by you. Please refer to [Section 4.13.1, “FPGA Registers”](#) for details on how to program the FPGA’s interrupt controller.

4.8 Audio

A stereo audio codec is connected to the MCF5445x’s SSI interface. The SSI operates in I²S mode to transfer audio data to and from a TLV320AIC23B device. The codec’s control communications SPI channel is accessed through the MCF5445x’s DSPI interface using DSPI_PCS5. The line-in, line-out, and microphone inputs of the codec are brought to a 3.5-mm triple audio connector with PC-99 standard color coding. Refer to [Section 2.4, “I/O Back Panel”](#) for location and connection information.

For accessibility ease, all the SSI signals from the MCF5445x are brought to a header, J910.

Table 9. SSI Signals on J910

Signal Name	Pin	Pin	Signal Name
SSI_RXD	1	2	SSI_TXD
SSI_MCLK	3	4	SSI_BCLK
SSI_FS	5	6	GND

4.9 BDM and JTAG

The primary debug port on the MCF5445x is referred to as the background debug module or BDM. The standard 26-pin BDM header (J24) is provided on the M54455EVB for attachment of an external BDM control interface. However, the M54455EVB also features a built-in P&E USB ColdFire Multilink. This interface is brought out to the I/O back panel to a standard Type-B USB receptacle. Refer to [Section 2.4, “I/O Back Panel”](#) for the location of the connector. This allows for run-control debugging with a standard USB cable (provided in the M54455EVB kit).

The MCF5445x also features IEEE 1149.1 Test Access Port (JTAG) test logic that can be used for boundary-scan testability. The access pins for JTAG are multiplexed over the BDM control signals and are available on J24.

The JTAG_EN input signal to the MCF5445x determines the debug mode: BDM or JTAG. This signal is controllable by JP903 as shown below.

Table 10. Debug Mode Selection

JP903 Setting	Debug Mode
Shunt on 1-2	JTAG
Shunt on 2-3	BDM

The TCLK and PSTCLK signals are the only two multiplexed signals that switch input/output state depending on which debug mode is selected. In BDM mode, the PSTCLK is an output from the MCF5445x to the external BDM control interface. In JTAG mode, TCLK is the test clock input. The standard 26-pin BDM header defines pin 24 as PSTCLK. A common practice is to place TCLK on pin 6 of this header. JP904 is available to control the routing of the multiplexed TCLK_PSTCLK signal to the 26-pin debug header (J24) as shown below.

Table 11. TCLK/PSTCLK Routing Control

JP904 Setting	TCLK_PSTCLK Routing
Shunt on 1-2	TCLK/PSTCLK on J24[24] ¹
Shunt on 2-3	TCLK/PSTCLK on J24[6] ²

¹ This setting is required if an external BDM control interface is used. If the on-board USB Multilink is used, this jumper setting is ignored.

² This pin was previously specified by Freescale as Developer Reserved. External BDM control cables may be able to make use of this pin for JTAG instructions. There is a 10-k Ω pull-down resistor on the TCK_PSTCLK signal when this setting is selected.

4.10 USB

The MCF5445x integrates a USB 2.0 dual-role module with the following features:

- Support for host and device modes
- Support for full speed (FS) and low speed (LS) via an on-chip FS/LS transceiver
- Optional UTMI+ Low Pin Count Interface (ULPI) to support high speed (HS) transfers as well as FS and LS
- Uses 60 MHz reference clock based off of the system clock or from an external pin

The M54455EVB provides two interfaces to the single MCF5445x USB controller. Only one of these interfaces can be used at any one time.

4.10.1 On-Chip FS/LS Transceiver

The on-chip FS/LS transceiver signals are brought out to a type-A USB connector and are intended to be used for USB host applications. 15-k Ω pull-down and 33- Ω series resistors are provided on the D+ and D- data signals. Power to the connector is provided by an external dual-channel power distribution switch (MIC2026-1YM, U928). The B-channel of this device supplies the power for the type-A connector and is controlled by the MCF5445x USB_VBUS_EN output control signal.

When the on-chip FS/LS transceiver is used, the ULPI PHY can be put into its reset state. Refer to [Section 4.14, “CPLD”](#) for details.

4.10.2 ULPI PHY

The ULPI interface of the MCF5445x is also featured on the M54455EVB. An external ULPI physical layer device, the SMSC USB3300 (U927), connects directly to the MCF5445x ULPI interface. The USB signals from the ULPI PHY are brought out to a mini-AB USB connector. The ID pin on the mini-AB connector connects to the ULPI PHY's ID pin and indicates whether a host or device is connected. The ULPI PHY has an enable signal connected to the A-channel of the MIC2026 power distribution switch that is used to supply VBUS when operating as a host.

The RESET signal input to the ULPI PHY is controlled by the system's CPLD. Refer to [Section 4.14, “CPLD”](#) for details.

4.11 Ethernet

The MCF5445x processor features two Fast Ethernet controllers (FEC) with MII and RMII interface options. The M54455EVB provides a dual 10/100 Mbps Ethernet PHY to interface with the processor's FECs. The PHY operates in dual RMII mode. The board also provides two RJ45 connectors with integrated magnetics and LEDs.

The dual-port 10/100 Mbps provides a power-down feature for each port. You can control these power down signals via the system's CPLD.

NOTE

The FEC1 RMII interface signals on the MCF5445x are multiplexed with the upper eight bits of the ATA data bus. You must select between using the FEC1 interface or the full ATA interface. The system's CPLD provides control for this selection. Refer to [Section 4.14, "CPLD"](#) for details.

4.12 ATA

The M54455EVB provides a standard 40-pin ATA connector, as well as an external ATA data buffer that interfaces with the MCF5445x processor's ATA interface.

A device connected to the ATA Interface must be powered by a separate supply. Several peripheral power connectors are provided by the ATX power supply inside the case of the M54455EVB.

NOTE

Some of the ATA interface signals on the MCF5445x are multiplexed with the FEC1 RMII interface signals. To have access to the full 16-bit ATA data bus, the FEC1 interface must be disabled. The system's CPLD provides control for this selection. Refer to [Section 4.14, "CPLD"](#) for details.

4.13 FPGA

The M54455EVB FPGA is a Xilinx Spartan 3 FPGA that provides interrupt control for the four PCI slots and the pushbuttons SW6 and SW7. It also provides a buffered FlexBus interface to the external 256K × 16bit MRAM and an interface to a seven-segment display and two LEDs.

4.13.1 FPGA Registers

The FPGA implements several FlexBus accessible memory-mapped registers. [Table 12](#) shows the memory map and the following sections provide details on each register.

NOTE

Use only 32-bit reads and writes to these registers.

Table 12. FPGA Memory Map

Address	Register	Width (bits)	Access	Reset Value	Section/Page
0x0900_0000	FPGA interrupt request enable register (FPGA_IRQEN)	32	R/W	0x0000_0000	4.13.1.1/23
0x0900_0004	FPGA interrupt request status register (FPGA_IRQSTATUS)	32	R	0x0000_0000	4.13.1.2/23
0x0900_0008	FPGA PCI clock configuration register (FPGA_PCICLKCFG)	32	R/W	0x0000_0004	4.13.1.3/24
0x0900_000C	FPGA interrupt request routing register (FPGA_IRQROUTE)	32	R/W	0x0000_0039	4.13.1.4/24
0x0900_0010	FPGA version register (FPGA_VERSION)	32	R	0x1A00_0102	4.13.1.5/25
0x0900_0014	FPGA seven segment display register (FPGA_7SEGMENT)	32	R/W	0x0000_0000	4.13.1.6/26
0x0900_0018	FPGA LED control register (FPGA_LEDS)	32	R/W	0x0000_0000	4.13.1.7/26

4.13.1.1 FPGA Interrupt Request Enable Register (FPGA_IRQEN)

Address: 0x0900_0000 (FPGA_IRQEN)

	31	30	29	28	27	26	25	24	23	22	21	20	19	18	17	16	15	14	13	12	11	10	9	8	7	6	5	4	3	2	1	0
R	0	0	0	0	0	0	0	0	0	0	0	0	0	0	0	0	0	0	0	0	0	0	0	0	0	0	0	0	0	0	0	0
W																												SW7	SW6	PCI		
Reset	0	0	0	0	0	0	0	0	0	0	0	0	0	0	0	0	0	0	0	0	0	0	0	0	0	0	0	0	0	0	0	0

Figure 4-12. FPGA_IRQEN Register

Table 13. FPGA_IRQEN Field Descriptions

Field	Description
31–6	Reserved, must be cleared.
5 SW7	Setting this bit allows the SW7 pushbutton interrupt source to be passed through to the IRQ line determined by FPGA_IRQROUTE. 1 SW7 interrupt is enabled 0 SW7 interrupt source does not assert an IRQ
4 SW6	Setting this bit allows the SW6 pushbutton interrupt source to be passed through to the IRQ line determined by FPGA_IRQROUTE. 1 SW6 interrupt is enabled 0 SW6 interrupt source does not assert an IRQ
3–0 PCI	Setting these bits allow the corresponding PCI interrupt source to be passed through to the IRQ line determined by FPGA_IRQROUTE. 1 Corresponding PCI interrupt is enabled 0 Corresponding PCI interrupt source does not assert an IRQ

4.13.1.2 FPGA Interrupt Request Status Register (FPGA_IRQSTATUS)

Address: 0x0900_0004 (FPGA_IRQSTATUS)

	31	30	29	28	27	26	25	24	23	22	21	20	19	18	17	16	15	14	13	12	11	10	9	8	7	6	5	4	3	2	1	0
R	0	0	0	0	0	0	0	0	0	0	0	0	0	0	0	0	0	0	0	0	0	0	0	0	0	0	0	0	0	0	0	0
W																																
Reset	0	0	0	0	0	0	0	0	0	0	0	0	0	0	0	0	0	0	0	0	0	0	0	0	0	0	0	0	0	0	0	0

Figure 13. FPGA_IRQSTATUS Register

Table 14. FPGA_IRQSTATUS Field Descriptions

Field	Description
31–6	Reserved, must be cleared.
5 SW7	Indicates the SW7_b signal is asserted. This bit shows the status of the interrupt, even if FPGA_IRQEN[SW7] is cleared.
4 SW6	Indicates the SW6_b signal is asserted. This bit shows the status of the interrupt, even if FPGA_IRQEN[SW6] is cleared.
3–0 PCI	Indicates the corresponding interrupt $\overline{PCI_IRQ}$ line is asserted. These bits show the status of interrupt, even if the corresponding FPGA_IRQEN[PCI] bit is cleared.

4.13.1.3 FPGA PCI Clock Configuration Register (FPGA_PCICLKCFG)

Address: 0x0900_0008 (PCI_CLK_CFG)

	31	30	29	28	27	26	25	24	23	22	21	20	19	18	17	16	15	14	13	12	11	10	9	8	7	6	5	4	3	2	1	0	
R	0	0	0	0	0	0	0	0	0	0	0	0	0	0	0	0	0	0	0	0	0	0	0	0	0	0	0	0	0	0	M66 EN	CLKGEN S2	CLKGEN S2EN
W																																	
Reset	0	0	0	0	0	0	0	0	0	0	0	0	0	0	0	0	0	0	0	0	0	0	0	0	0	0	0	0	0	1 ¹	0	0	

Figure 14. FPGA_PCICLKCFG Register

¹ This value is reset to 0 if not using the ATX power supply.

Table 15. FPGA_PCICLKCFG Field Descriptions

Field	Description
31–3	Reserved, must be cleared.
2 M66EN	State of the M66EN pin from the PCI slots. 0 33MHz card is installed in a PCI slot. The input clock and PCI clocks is 33MHz 1 Non 33MHz cards are installed. PCI speed is determined by CLKGENS2EN and/or external jumper on header H4[3:4]
1 CLKGENS2	State of the S2 control input to the CY22393 clock generator. For the S2 pin to assert, M66EN must be set, the jumper across pins 3 and 4 on H4 must be removed, and CLKGENS2EN must be set. 0 Input clock and PCI clocks are operating at 33MHz 1 Input clock and PCI clocks are operating at 66MHz
0 CLKGENS2EN	Assert the S2 control input to the CY22393 clock generator. If the M66EN pin is pulled-low, this bit is ignored. A jumper shunt across H4[3:4] also overrides this setting and force 33MHz operation. The CLKGENS2 bit always reflects the current state of the S2 signal. 0 Set input clock and PCI clocks to 33MHz 1 Set input clock and PCI clocks to 66MHz

4.13.1.4 FPGA Interrupt Request Routing Register (FPGA_IRQROUTE)

Address: 0x0900_000C (FPGA_IRQROUTE)

	31	30	29	28	27	26	25	24	23	22	21	20	19	18	17	16	15	14	13	12	11	10	9	8	7	6	5	4	3	2	1	0		
R	0	0	0	0	0	0	0	0	0	0	0	0	0	0	0	0	0	0	0	0	0	0	0	0	0	0	0	0	0	0	0	0		
W																												SW7	SW6	PCI				
Reset	0	0	0	0	0	0	0	0	0	0	0	0	0	0	0	0	0	0	0	0	0	0	0	0	0	0	0	0	1	1	1	0	0	1

Figure 15. FPGA_IRQROUTE Register

Table 16. FPGA_IRQROUTE Field Descriptions

Field	Description
31–6	Reserved, must be cleared.
5–4 SW7	SW7 IRQ selection (pushbutton) 00 IRQ1 01 IRQ3 10 IRQ4 11 IRQ7

Table 16. FPGA_IRQROUTE Field Descriptions (continued)

Field	Description
3–2 SW6	SW6 IRQ selection (pushbutton) 00 IRQ1 01 IRQ3 10 IRQ4 11 IRQ7
1–0 PCI	PCI IRQ selection 00 IRQ1 01 IRQ3 10 IRQ4 11 IRQ7

4.13.1.5 FPGA Version Register (FPGA_VERSION)

The FPGA_VERSION register reflects the version of the FPGA code image.

Address: 0x0900_0010 (FPGA_VERSION)

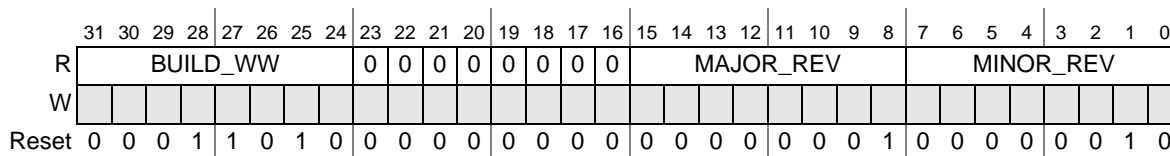

Figure 16. FPGA Version Register

Table 17. FPGA_VERSION Field Descriptions

Field	Description
31–24 BUILD_WW	Build date work week
23–16	Reserved, must be cleared.
15–8 MAJOR_REV	Major revision number. Example: Revision 1.2 of the FPGA code. MAJOR_REV = 0x01, MINOR_REV = 0x02
7–0 MINOR_REV	Minor revision number. Example: Revision 1.2 of the FPGA code. MAJOR_REV = 0x01, MINOR_REV = 0x02

4.13.1.6 FPGA Seven Segment Display Register (FPGA_7SEGMENT)

Address: 0x0900_0014 (FPGA_7SEGMENT)

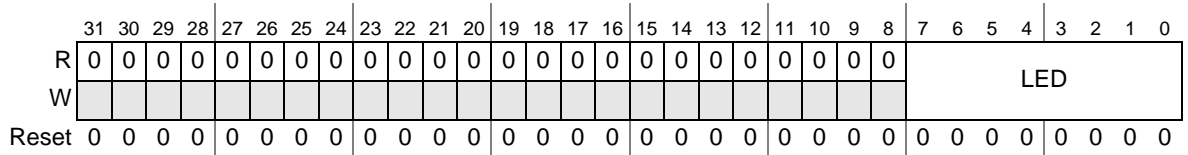

Figure 17. FPGA_7SEGMENT Register

Table 18. FPGA_7SEGMENT Field Descriptions

Field	Description
31–8	Reserved, must be cleared.
7–0 LED	Indicates the hex number you want to display on the 7-segment LED display (U28 on the EVB).

4.13.1.7 FPGA LED Control Register (FPGA_LEDS)

Address: 0x0900_0018 (FPGA_LEDS)

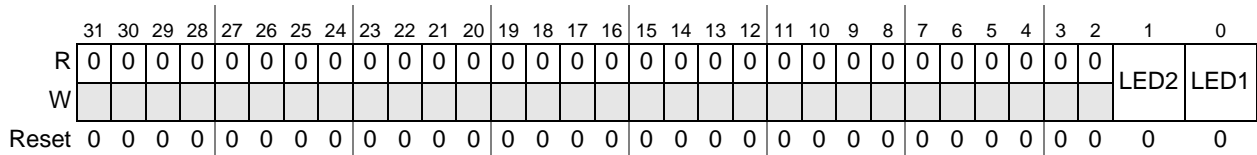

Figure 18. FPGA_LEDS Register

Table 19. FPGA_LEDS Field Descriptions

Field	Description
31–2	Reserved, must be cleared.
1 LED2	Controls the state of FPGA_LED2. FPGA_LED2 is reference designator D956. 0 Off 1 On
0 LED1	Controls the state of FPGA_LED1. FPGA_LED1 is reference designator D957. 0 Off 1 On

4.14 CPLD

A Xilinx XC95144XL CPLD performs a number of tasks on the M54455EVB including:

- Reset control
- Boot mode selection
- Peripheral multiplexing and enable/disable control
- LED control
- Board revision determination

Section 4.2, “Reset Controller” provides detailed information on the CPLD’s role as reset controller. Boot mode selection information is provided in Section 4.3, “MCF5445x Boot Options”. The other functional blocks of the CPLD are described in the sections below.

4.14.1 CPLD Mode Control

The CPLD outputs several signals to enable, disable, and control signal routing to and from several peripherals on the M54455EVB. The state of these signals is controllable via a bank of eight DIP switches (SW1) and a Flexbus-accessible memory-mapped register, CPLD_CONTROL. The CPLD_MODE register reflects the value of the switches at reset. Table 20 summarizes the controllable CPLD mode selection settings.

Table 20. CPLD Mode Configuration Switch

SW1 Switches	Description	Output Signals Affected
1 & 2	Boot mode configuration	BOOTMOD[1:0]
3	Boot flash selection	$\overline{\text{FLASH1_CS}}$ $\overline{\text{FLASH0_CS}}$
4 ¹	ULPI PHY reset control	$\overline{\text{ULPI_RESET}}$
5 ¹	ATA/FEC1 selection	$\overline{\text{ATA_ENABLE}}$ $\overline{\text{PHY1_PWRDN}}$ $\overline{\text{RMIICLK2_EN}}$
6 ¹	FEC0 PHY power down	$\overline{\text{PHY0_PWRDN}}$
8	MCF5445x test mode	TEST

¹ These switch settings can be overridden by software via the CPLD_CONTROL register

4.14.1.1 Boot Mode Configuration

The following table shows the switch settings that control the boot configuration options. Section 4.3, “MCF5445x Boot Options” provides detailed information on the available boot options.

Table 21. CPLD Boot Mode Selection

SW1 [1]	SW1 [2]	Meaning
ON	ON	Boot from Flexbus with defaults (from RCON register)
OFF	ON	Reserved
ON	OFF	Boot from Flexbus and override defaults via data bus (FB_AD[7:0])
OFF	OFF	Boot from Flexbus and override defaults via serial boot facility (SPI memory)

4.14.1.2 Boot Flash Selection

The CPLD determines how to route Flexbus chip-selects $\overline{\text{FB_CS0}}$ and $\overline{\text{FB_CS1}}$ to the two flash devices. The flash connected to $\overline{\text{FB_CS0}}$ is the boot device. Refer to Section 4.6, “Flash” for more information.

Table 22. Flash Chip Select Configuration

SW1 [3]	Meaning	Application
OFF	Flash1 is the boot device $\overline{\text{FLASH1_CS}} = \overline{\text{FB_CS0}}$ $\overline{\text{FLASH0_CS}} = \overline{\text{FB_CS1}}$	Boot custom image
ON	Flash0 is the boot device $\overline{\text{FLASH1_CS}} = \overline{\text{FB_CS1}}$ $\overline{\text{FLASH0_CS}} = \overline{\text{FB_CS0}}$	Boot U-Boot

4.14.1.3 ULPI PHY Reset Control

The ULPI PHY's RESET signal is connected to the ULPI_RESET output from the CPLD. When this signal is asserted, the PHY is held in its reset state. When using the on-chip FS/LS transceiver USB interface, this switch should be ON. Refer to [Section 4.10, "USB"](#) for more details.

NOTE

The ULPI PHY still drives CLKOUT even when it is held in reset.

Table 23. ULPI PHY Reset Control

SW1 [4]	Meaning
OFF	ULPI chip not held in reset state (ULPI_RESET deasserted/driven low)
ON	ULPI chip held in reset state (ULPI_RESET asserted/driven high)

4.14.1.4 ATA/FEC1 Selection

The upper eight bits of the ATA data bus are multiplexed with the FEC1 RMI interface. To use the full ATA interface, the FEC1 interface must be disabled. The MCF5445x provides pin assignment control to route the proper integrated peripheral signals to the external pins. The M54455EVB provides this switch and a programmable bit in the CPLD_CONTROL register to select the appropriate board level routing.

The upper half of the ATA level-shifting buffer is controlled by the CPLD output signal $\overline{\text{ATA_ENABLE}}$. When this signal is asserted, the multiplexed ATA/FEC1 signals from the MCF5445x is enabled to/from the 40-pin ATA connector.

The FEC1 port of the dual-port 10/100-Mbps Ethernet PHY is powered down when the $\overline{\text{PHY1_PWRDN}}$ signal is asserted by the CPLD.

The ATA_DATA11 pin is multiplexed with the FEC1_RMII_REF_CLK clock. This clock is generated by the CY22393 clock generator and driven through a buffer controlled by the CPLD's RMIICLK2_EN signal. When the $\overline{\text{ATA_ENABLE}}$ signal is asserted, the RMIICLK2_EN signal is deasserted, shutting off the clock and allowing this signal to be used as ATA_DATA11.

Table 24. ATA/FEC1 Selection

SW1 [5]	Meaning
OFF	<ul style="list-style-type: none"> • Full ATA bus enabled ($\overline{\text{ATA_ENABLE}}$ asserted/driven low) • PHY1 powered down ($\overline{\text{PHY1_PWRDN}}$ asserted/driven low) • RMIICK2 is disabled ($\overline{\text{RMIICK2_EN}}$ deasserted/driven low)
ON	<ul style="list-style-type: none"> • Upper 8 bits of the ATA data bus disabled ($\overline{\text{ATA_ENABLE}}$ deasserted/driven high) • PHY1 active ($\overline{\text{PHY1_PWRDN}}$ deasserted/driven high) • RMIICK2 is enabled ($\overline{\text{RMIICK2_EN}}$ asserted/driven high)

4.14.1.5 FEC0 PHY Power Down

The FEC0 port of the dual-port 10/100-Mbps Ethernet PHY can be powered down by the CPLD's $\overline{\text{PHY0_PWRDN}}$ signal. The default state of this signal is determined by SW1[6], but it can be overridden by the CPU via the CPLD_CONTROL register.

Table 25. FEC0 PHY Power Down

SW1 [6]	Meaning
OFF	PHY0 active ($\overline{\text{PHY0_PWRDN}}$ deasserted/driven high)
ON	PHY0 powered down ($\overline{\text{PHY0_PWRDN}}$ asserted/driven low)

4.14.1.6 MCF5445x Test Mode

The MCF5445x test mode enable (active high) signal state is controlled by the CPLD's TEST signal. The state of this signal is determined by SW1[8].

NOTE

Test mode is for Freescale test purposes only. Enabling test mode places the MCF5445x into a non-functional state.

Table 26. MCF5445x Test Mode

SW1 [8]	Meaning
OFF	MCF5445x in normal function mode
ON	MCF5445x in factory test mode Note: This setting is for Freescale use only and places the MCF5445x into a non-functional mode.

4.14.2 M54455EVB Revision

Optionally populated resistors on the M54455EVB allow the revision to be indicated at the time of assembly. These resistors connections input to the CPLD, and the values can be read from CPLD_VERSION register. Refer to the description of the CPLD registers below.

4.14.3 CPLD Configuration and Status Registers

The following sections describe the CPLD registers.

NOTE

Use only 8-bit reads and writes to these registers.

Table 27. CPLD Memory Map

Address	Register	Width (bits)	Access	Reset Value	Section/Page
0x0800_0000	CPLD version register (CPLD_VERSION)	8	R	See Section	4.14.3.1/30
0x0800_0001	CPLD control register (CPLD_CONTROL)	8	R/W	See Section	4.14.3.2/31
0x0800_0002	CPLD on-die termination register (CPLD_SDODT)	8	R/W	0x00	4.14.3.3/31
0x0800_0003	CPLD mode register (CPLD_MODE)	8	R	[CPLD_MODE]	4.14.3.4/32
0x0800_0004	CPLD flash configuration register (CPLD_FLASHCFG)	8	R/W	0x01	4.14.3.5/32
0x0800_0005	CPLD LED control register (CPLD_LEDS)	8	R/W	0x00	4.14.3.6/33

4.14.3.1 CPLD Version Register (CPLD_VERSION)

This register provides read access to the board version. The version is set by a set of four revision signals that are connected from the CPLD to a pull-up or pull-down resistor.

Address: 0x0800_0000 (CPLD_VERSION)

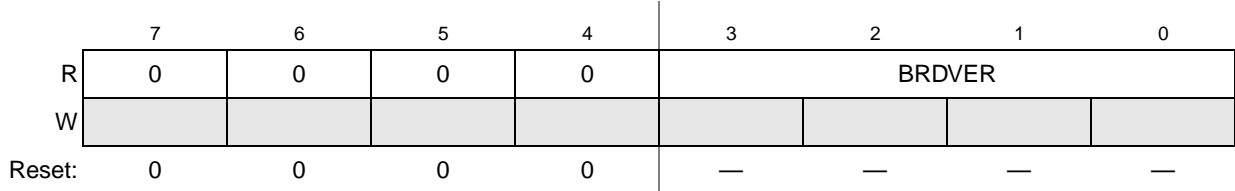

Figure 19. CPLD_VERSION Register

Table 28. CPLD_VERSION Field Descriptions

Field	Description
7–4	Reserved
3–0 BRDVER	Board version. This field reflects the current M54455EVB revision. The value here is the one less than the current version of the board (e.g. CPLD_BRDVER of 0x01 indicates M54455EVB Rev 2).

4.14.3.2 CPLD Control Register (CPLD_CONTROL)

Following reset, $\overline{\text{PHY0_PWRDN}}$, $\overline{\text{ATA_ENABLE}}$, and $\overline{\text{ULPI_RESET}}$ pins are set according to the CPLD_MODE switch (SW1) settings. The CPLD_CONTROL register allows you to override these switch settings.

Address: 0x0800_0001 (CPLD_CONTROL)

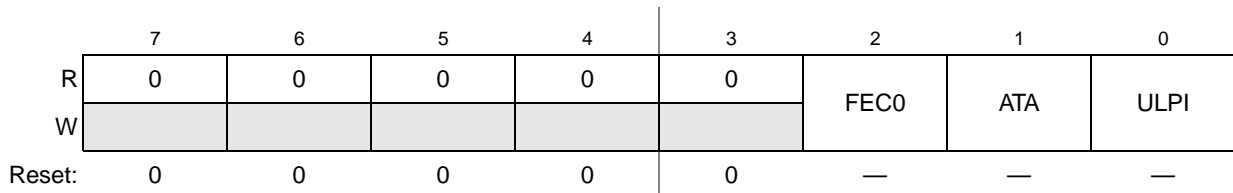

Figure 20. CPLD_CONTROL Register

Table 29. CPLD_CONTROL Field Descriptions

Field	Description
7–3	Reserved, must be cleared.
2 FEC0	FEC0 PHY mode 0 FEC0 Ethernet PHY in normal/functional mode 1 FEC0 Ethernet PHY in power down mode
1 ATA	ATA and FEC1 PHY mode 0 Full ATA data bus enabled/FEC1 PHY in power down mode 1 Upper 8-bits of ATA data bus disabled; FEC1 PHY in normal/functional mode
0 ULPI	ULPI PHY mode 0 ULPI PHY in normal/functional mode 1 ULPI PHY held in reset state

4.14.3.3 CPLD On-Die Termination Register (CPLD_SDODT)

CPLD_SDODT controls the DDR SDRAM on-die termination pins.

Address: 0x0800_0002 (CPLD_SDODT)

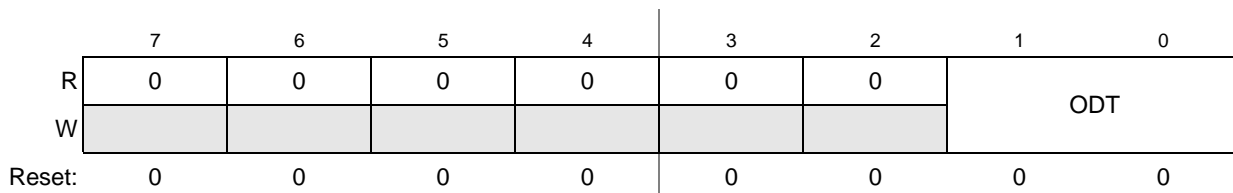

Figure 21. CPLD_SDODT Register

Table 30. CPLD_SDODT Field Descriptions

Field	Description
7–2	Reserved, must be cleared.
1–0 ODT	Control state of the corresponding DDR SDRAM on-die termination pins. These pins are for test purposes only. The M54455EVB provides external parallel termination for the DDR2 interface.

4.14.3.4 CPLD Mode Register (CPLD_MODE)

CPLD_MODE reflects the current status of the SW1 switch.

Address: 0x0800_0003 (CPLD_MODE)

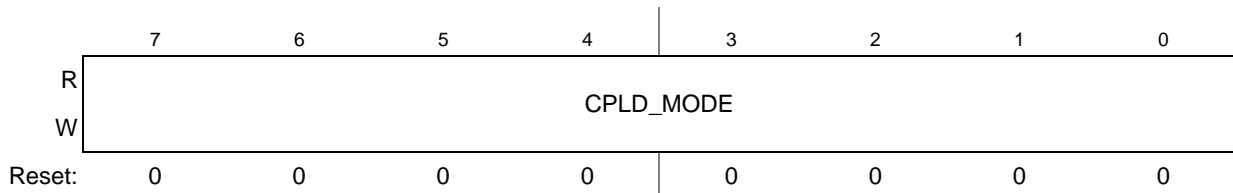

Figure 22. CPLD_MODE Register

Table 31. CPLD_MODE Field Descriptions

Field	Description
7–0 CPLD_MODE	Status of the CPLD_MODE[7:0] signals which are controllable via the SW1 switch. 0 Corresponding SW1 switch is in the ON position 1 Corresponding SW1 switch is in the OFF position

4.14.3.5 CPLD Flash Configuration Register (CPLD_FLASHCFG)

CPLD_FLASHCFG controls the write-protect feature of Flash1

Address: 0x0800_0004 (CPLD_FLASHCFG)

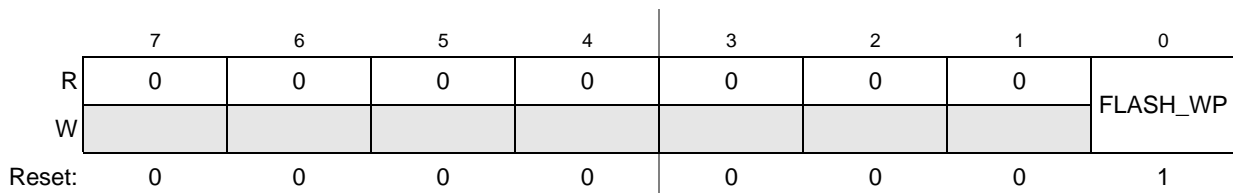

Figure 23. CPLD_FLASHCFG Register

Table 32. CPLD_FLASHCFG Field Descriptions

Field	Description
7–1	Reserved, must be cleared.
0 FLASH_WP	Flash1 write-protect. This bit controls the state of the FLASH1_WP signal 0 Flash1 is write-protected 1 Flash1 is not write-protected

4.14.3.6 CPLD LED Control Register (CPLD_LEDS)

CPLD_LEDS controls the state of the CPLD's LEDs.

Address: 0x0800_0005 (CPLD_LEDS)

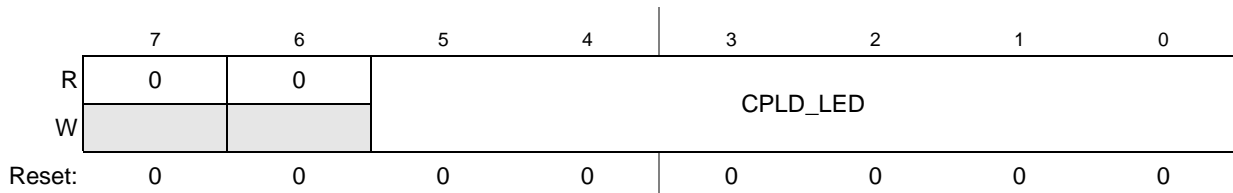

Figure 24. CPLD_LEDS Register

Table 33. CPLD_LEDS Field Descriptions

Field	Description
7–6	Reserved, must be cleared.
5–0 CPLD_LED	Controls the state of the CPLD's LED[5:0] signals. LED[5:0] corresponds to D35–D30. 0 Corresponding CPLD LED is OFF 1 Corresponding CPLD LED is ON

4.15 Interrupts

The four external MCF5445x interrupt requests are driven by the FPGA. The FPGA gathers four PCI interrupts from the PCI slots, along with two pushbutton interrupts, and presents them to the MCF5445x. Refer to [Section 4.13, “FPGA”](#) for details on how to enable and route the interrupts.

4.16 Serial Interface Header

The MCF5445x contains a few serial interfaces and timers that are not made available via dedicated interfaces on the M54455EVB. However, these interfaces (and others) are brought out to a general purpose header, J908, for easy access. The following interfaces are accessible on J908:

- DSPI
- I²C
- DMA external request/acknowledge
- DMA timer input/output
- UART0
- UART1

[Table 34](#) shows the signal assignments on J908.

Table 34. J908 Signal Assignments

Signal Name	Pin		Signal Name
VDD	1	2	GND
VDD	3	4	GND
U1CTS	5	6	U0TXD
U1RTS	7	8	U0RXD
U1RXD	9	10	U0RTS
U1TXD	11	12	U0CTS
GND	13	14	GND
SYSRESET	15	16	I2C_SCL
CPU_RSTOUT	17	18	I2C_SDA
GND	19	20	GND
T3IN	21	22	IRQ7
T2IN	23	24	IRQ4
T1IN	25	26	IRQ3
T0IN	27	28	IRQ1
GND	29	30	GND
DSPI_SCK	31	32	DSPI_PCS0
DSPI_SIN	33	34	DSPI_PCS1
DSPI_SOUT	35	36	DSPI_PCS2
DSPI_PCS5	37	38	DACK0
GND	39	40	DREQ0

4.17 Serial Ports

The MCF5445x includes three UART modules. The M54455EVB provides two standard RS232 line drivers on UART0 and UART1, connected to a dual, stacked DB9 serial port connector (male). The RS232 null-modem cable provided in the kit can connect the serial ports to a host PC.

The EVB also supplies an optional USB-to-UART bridge (Silicon Labs CP2102) to interface with MCF5445x's UART0. If using this option, a USB type B connector can interface with a host PC instead of the standard RS232 connector. A custom virtual COMM port driver may be required on the host PC and can be found here:

http://www.silabs.com/tgwWebApp/public/web_content/products/Microcontrollers/USB/en/mcu_vcp.htm

NOTE

The virtual COMM port driver loses communication with the M54455EVB when the board is powered off and back on. You must force a reconnect in the serial terminal program following a power-on reset of the EVB. For this reason, it can be difficult to see power-on boot messages from the EVB when using the power button on the front of the M54455EVB's case. However, the EVB provides a reset button (SW2) which does not force the CP2102 to re-enumerate, and thus, does not require a reconnect in the serial terminal. This allows you to witness any reset messages, but requires that the case be opened so that SW2 can be accessed.

4.18 Logic Analyzer Connections

The M54455EVB provides 12 Tektronix P6860 compression connections for use with TLA7Axx logic analyzer modules. These probes allow you to probe Flexbus, PCI and DDR2 signals. See the M54455EVB schematics for more details.

4.19 Power Regulation

The M54455EVB provides two Freescale QuiccSupply MC34702 power regulators. These power regulators provide 3.3 V, 1.8 V, 1.5 V, and 1.2 V to devices on the board, with the exception of the PCI slots. The regulators generate these voltages from a 5-V external supply. The 5-V supply can be provided through one of the following: the ATX power connector, a barrel jack connector, or a 6-pin molex power connector to a lab-grade regulated supply.

Jumpers are provided that allow for the 3.3- and 1.5-V supplies to be separated from the MCF5445x. The intention of these jumpers is to connect a current meter to measure the power consumed by the MCF5445x processor or to allow for the injection of a variable voltage power supply for test purposes.

The PCI sockets are powered directly from the ATX supply, which allows for much higher PCI card power consumption. PCI is only available if an ATX supply powers the board. The ATX 5-V line is connected to the Freescale QuiccSupply MC34702 regulators. This isolates the power consumption of the PCI bus from the board ASICs.

4.20 Jumpers, Headers, and Switches

There are several jumpers on the M54455EVB that allow you to control the hardware configuration. The following table provides descriptions for all the jumper settings.

Table 35. Jumper Settings

Reference Designator	Setting ¹	Function
H4[1:2]	ON	Clock Generator Disable
	OFF ²	
H4[3:4]	ON	33MHz PCICLK/CLKIN Frequency
	OFF ²	66MHz PCICLK/CLKIN Frequency

Table 35. Jumper Settings (continued)

Reference Designator	Setting ¹	Function
H10	ON ²	Power Barrel Connector Enable
	OFF	
H11	ON	Enable VDD to the processor
	OFF ²	Disable VDD to the processor Note: R665 is fitted by default and bypasses H11
H12	ON	Enable VEE to the processor
	OFF ²	Disable VEE to the processor Note: R664 is fitted by default and bypasses H12
H13	ON	Enable V1.5 to the processor
	OFF ²	Disable V1.5 to the processor Note: R659 is fitted by default and bypasses H13
H21[1:2] H21[3:4] H21[5:6] H21[7:8]	ON	Connect I2C_SCL, I2C_SDA, ATA_BUFFER_EN, and DSPI_PCS2 from MCF5445x to FPGA program header pins
	OFF ²	
JP907 JP908	ON ²	Enable UART1 flow control signals
	OFF	Disable UART1 flow control signals
JP903	1:2	Boot into JTAG mode
	2:3 ²	Boot into BDM mode
JP904	1:2 ²	Connect BDM pin 24 to MCF5445x TCLK_PSTCLK
	2:3	Connect BDM pin 6 to MCF5445x TCLK_PSTCLK
JP909 JP910 JP911 JP912	1:2	Connect UART0 signals to DB9 interface
	2:3 ²	Connect UART0 signals to USB interface
JP918	1:2 ²	Connect MCF5445x USBCLKIN to CLKOUT of USB3300
	2:3	Connect MCF5445x USBCLKIN to 60MHz from external clock generator

¹ ON indicates that a shunt should be fitted on the jumper; OFF indicates that no shunt should be applied.

² Default setting.

The following table describes the interface headers.

Table 36. Interface Headers

Reference Designator	Function
H9	System power indicator for case LED
H14	Board reset header for case switch
H15	Power ON/OFF for case switch
H16	ATA activity indicator for case LED
H20	FPGA program header

Table 36. Interface Headers (continued)

Reference Designator	Function
H26	CPLD program header
H36	Alternate 12V supply for PCI cards. Default uses the ATX power supply (J50)
H900	Spare CPLD I/O pins
J21	Alternate power connector. Default uses the ATX power supply (J50)
J24	BDM/JTAG connector
J909	Serial interface breakout
J910	SSI interface signals

The following table provides a description of the various switches on the board.

Table 37. Switches

Reference Designator	Function
SW1	CPLD_MODE switch. See Section 4.14, "CPLD" for more information.
SW2	Board reset push-button
SW3	Parallel configuration switch. See Section 4.3, "MCF5445x Boot Options" for details.
SW4	ATX power ON/OFF button.
SW5	FPGA_CFG switch. Not used at this time
SW6	FPGA interrupt pushbutton 0.
SW7	FPGA interrupt pushbutton 1.

5 U-Boot

The M54455EVB comes pre-programmed with the U-Boot bootloader in the boot flash device, Flash0. U-Boot is an open source bootloader with some debugging capabilities. Please refer to <http://www.denx.de/wiki/UBoot> for documentation.

6 Revision History

Table 38. M54455EVBUM Revision History

Revision	Release Date	Changes
3	30 Aug 2007	Initial revision for public launch
4	30 Jan 2008	Changed step 8 in Installation and Configuration section from "bootm" to "bootm 0"

How to Reach Us:

Home Page:

www.freescale.com

Web Support:

<http://www.freescale.com/support>

USA/Europe or Locations Not Listed:

Freescale Semiconductor, Inc.
Technical Information Center, EL516
2100 East Elliot Road
Tempe, Arizona 85284
+1-800-521-6274 or +1-480-768-2130
www.freescale.com/support

Europe, Middle East, and Africa:

Freescale Halbleiter Deutschland GmbH
Technical Information Center
Schatzbogen 7
81829 Muenchen, Germany
+44 1296 380 456 (English)
+46 8 52200080 (English)
+49 89 92103 559 (German)
+33 1 69 35 48 48 (French)
www.freescale.com/support

Japan:

Freescale Semiconductor Japan Ltd.
Headquarters
ARCO Tower 15F
1-8-1, Shimo-Meguro, Meguro-ku,
Tokyo 153-0064
Japan
0120 191014 or +81 3 5437 9125
support.japan@freescale.com

Asia/Pacific:

Freescale Semiconductor Hong Kong Ltd.
Technical Information Center
2 Dai King Street
Tai Po Industrial Estate
Tai Po, N.T., Hong Kong
+800 2666 8080
support.asia@freescale.com

For Literature Requests Only:

Freescale Semiconductor Literature Distribution Center
P.O. Box 5405
Denver, Colorado 80217
1-800-441-2447 or 303-675-2140
Fax: 303-675-2150
LDCForFreescaleSemiconductor@hibbertgroup.com

Document Number: M54455EVBUM
Rev. 4
01/2008

Information in this document is provided solely to enable system and software implementers to use Freescale Semiconductor products. There are no express or implied copyright licenses granted hereunder to design or fabricate any integrated circuits or integrated circuits based on the information in this document.

Freescale Semiconductor reserves the right to make changes without further notice to any products herein. Freescale Semiconductor makes no warranty, representation or guarantee regarding the suitability of its products for any particular purpose, nor does Freescale Semiconductor assume any liability arising out of the application or use of any product or circuit, and specifically disclaims any and all liability, including without limitation consequential or incidental damages. "Typical" parameters that may be provided in Freescale Semiconductor data sheets and/or specifications can and do vary in different applications and actual performance may vary over time. All operating parameters, including "Typicals", must be validated for each customer application by customer's technical experts. Freescale Semiconductor does not convey any license under its patent rights nor the rights of others. Freescale Semiconductor products are not designed, intended, or authorized for use as components in systems intended for surgical implant into the body, or other applications intended to support or sustain life, or for any other application in which the failure of the Freescale Semiconductor product could create a situation where personal injury or death may occur. Should Buyer purchase or use Freescale Semiconductor products for any such unintended or unauthorized application, Buyer shall indemnify and hold Freescale Semiconductor and its officers, employees, subsidiaries, affiliates, and distributors harmless against all claims, costs, damages, and expenses, and reasonable attorney fees arising out of, directly or indirectly, any claim of personal injury or death associated with such unintended or unauthorized use, even if such claim alleges that Freescale Semiconductor was negligent regarding the design or manufacture of the part.

RoHS-compliant and/or Pb-free versions of Freescale products have the functionality and electrical characteristics as their non-RoHS-compliant and/or non-Pb-free counterparts. For further information, see <http://www.freescale.com> or contact your Freescale sales representative.

For information on Freescale's Environmental Products program, go to <http://www.freescale.com/epp>.

Freescale™ and the Freescale logo are trademarks of Freescale Semiconductor, Inc. All other product or service names are the property of their respective owners.
© Freescale Semiconductor, Inc. 2008. All rights reserved.

